

DOMESTICA

Lavapanni domestica con piedini 60X50XH86

- PDL6050B

Mobile in truciolare nobilitato da 18 mm., idrofugo a norme EN.

COLAVENE

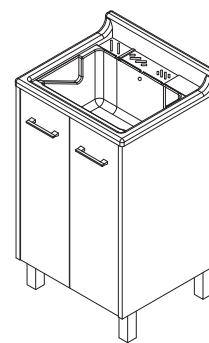

Disegni Tecnici

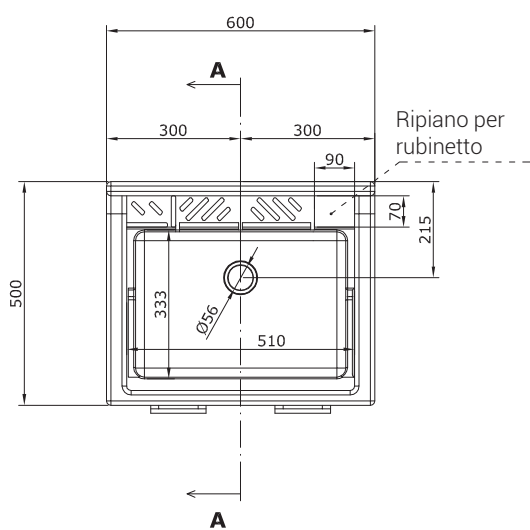

PIANTA

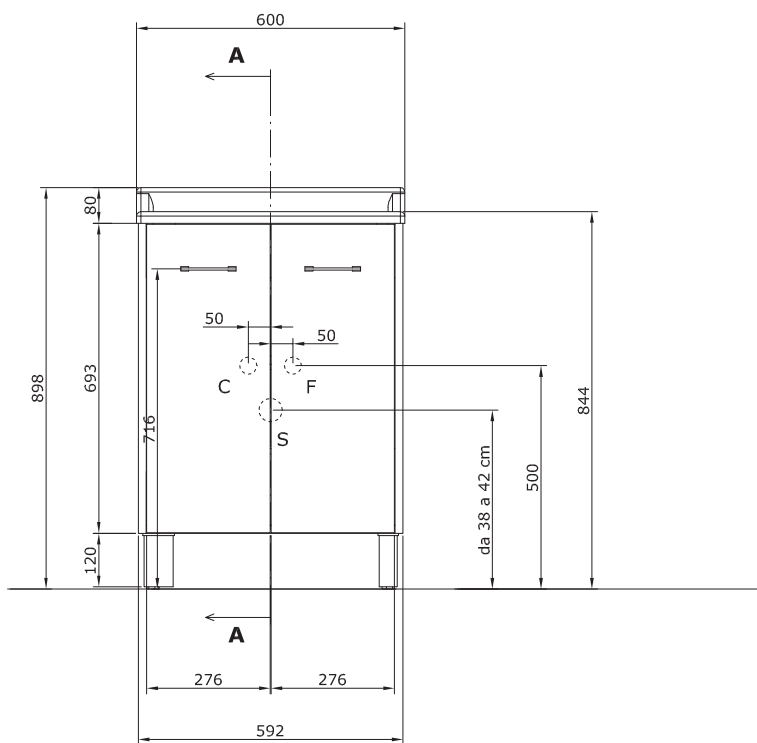

VISTA FRONTALE

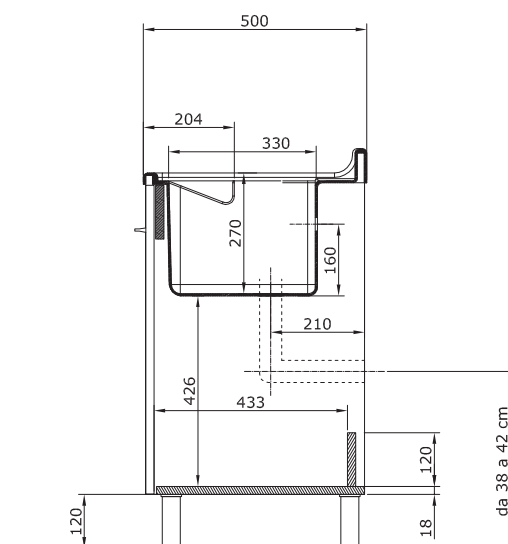

SEZIONE A-A

Escursione altezza Piedini
30 mm